

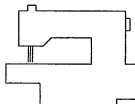

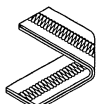

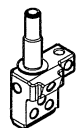

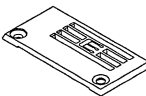

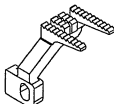
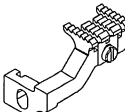
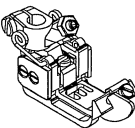



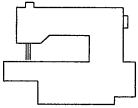
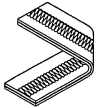
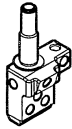
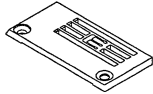
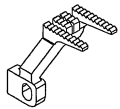
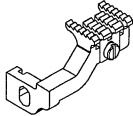
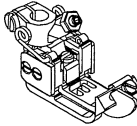



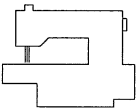
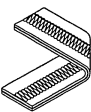
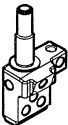
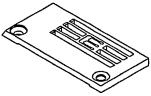
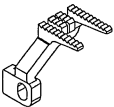
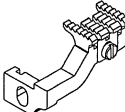
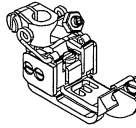



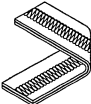
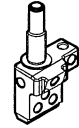
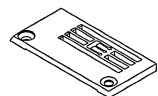
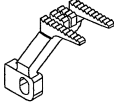
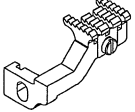
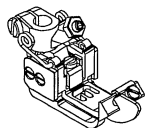

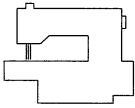
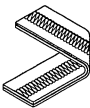
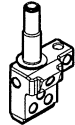
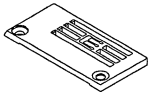
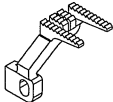
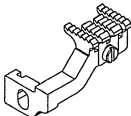
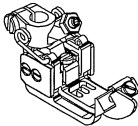

SIRUBA GAGE PARTS LIST		Series			Remark				Page	Date
		C007K / C858K C007KD / C858KD							1 / 7	2015/11/26
										
MODEL		SUB-CLASS	NEEDLE CLAMP	NEEDLE PLATE	MAIN FEED DOG	DIFF. FEED DOG	PRESSER FOOT	SPREADER	LOOPER	NEEDLE
機 型		規 格	針 座	針 板	主 送 具	差 送 具	押 具	上 叉	勾 針	針 號
C007K(KD) C858K(KD)	W121/CH			E5232KL E5240KL E5248KL E5348KL E5356KL E5364KL	D5356K	H5356KA-E	P5232A-A P5240A-A P5248A-A P5348A-A P5356A-A1 P5364A-A1	MH41	MT01	UYX128GAS#10
	W122/CH	232 240 248 348 356 364	M5232 M5240 M5248 M5348 M5356 M5364	E5232KM E5240KM E5248KM E5348KM E5356KM E5364KM						
	W122/CH-3M	356 364	M5356 M5364	E5356KM E5364KM						
	W123/CH	232 240 248 348 356 364	M5232 M5240 M5248 M5348 M5356 M5364	E5232KH E5240KH E5248KH E5348KH E5356KH E5364KH			P5232A-A P5240A-A P5248A-A P5348A-A P5356A-A1 P5364A-A1			
	W152/CZ/UTP/RLQ	356 364	M5356 M5364	E5356GM E5364GM	D5356G	H5356L	P2416-A P2417-A			
	W152/CZP/RLQ									



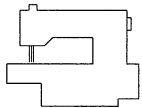
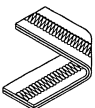
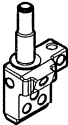
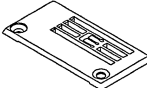
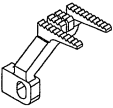
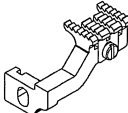
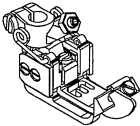

SIRUBA MODEL COMPARE LIST		Series				Remark			Page	Date		
		C007K / C858K C007KD / C858KD							2 / 7	2015/11/26		
												
MODEL		SUB-CLASS	NEEDLE CLAMP	NEEDLE PLATE	MAIN FEED DOG	DIFF. FEED DOG	PRESSER FOOT	SPREADER	LOOPER	NEEDLE		
機 型		規 格	針 座	針 板	主 送 具	差 送 具	押 具	上 叉	勾 針	針 號		
C007K(KD) C858K(KD)	W162/CH	240 248 348 356 364	M5240 M5248 M5348 M5356 M5364	E5240KHA E5248KHA E5348KHA E5356KHA E5364KHA	D5356K	H5356KA-E	P5240A-A P5248A-A P5348A-A P5356A-A1 P5364A-A1	MH41	MT01A	TV*5#14~16		
	W222/CQ	240 248 356 364	M5240 M5248 M5356 M5364	E5240GM E5248GM E5356GM E5364GM	D5356G	H5356GA	P1814K-A P1815K-A P2116K-A P2117K-A	MH41	MT01	UYX128GAS#10		
	W222/CQA/CLA	256 356	M5356	E2326Q	D2110	H2220Q	P2906Q-A	MH41	MT01A	TVX5#14		
	W322/CC	356 364	M5356 M5364	E5356AM E5364AM	D5356K	H5356AA	P2456-A P2457-A	MH41	MT01	UYX128GAS#10		
	W322/CE			E5356BM E5364BM		H5356BA						
C007K C858K	W512/FE(FFC)	232 240 356 364	M5232 M5240 M5356 M5364	E5232FM E5240FM E5356FM E5364FM	D5356K	H5356KA-E	P2913-A P2914-A P3216-A P3217-A				MT01	UYX128GAS#10
	U512/FE(FFC)	240 356 364	M5240 M5356 M5364	E5240FM E5356FM E5364FM			P3414-A P3716-A P3717-A					

SIRUBA GAGE PARTS LIST		Series					Remark			Page	Date
		C007K / C858K C007KD / C858KD								3 / 7	2015/11/26
											
MODEL		SUB-CLASS	NEEDLE CLAMP	NEEDLE PLATE	MAIN FEED DOG	DIFF. FEED DOG	PRESSER FOOT	SPREADER	LOOPER	NEEDLE	
機 型		規 格	針 座	針 板	主 送 具	差 送 具	押 具	上 叉	勾 針	針 號	
C007K C858K	W522/FE(FFC)/CR	232 240 248 348 356 364	M5232 M5240 M5248 M5348 M5356 M5364	E5232CH E5240CH E5232CH E5348CH E5356CH E5364CH	D5356C	H5356CA	P3813R-A1 P5240C-A1 P5248C-A1 P5348C-A1 P3816R-A1 P3817R-A1	MH41	MT01	UYX128GAS#10	
C007K(KD) C858K(KD)	W522/CR		P5232R-A P5240R-A P5248R-A P5348R-A P5356R-A P5364R-A								
	W532/CR/UTP/CL/RLP/CX										
C007K C858K	W542/CFC/CL/FH/2(3A)	240 248 356 364	M5240 M5248 M5356 M5364	E2324P E2325P E2326P E2327P	D2109 D2110	H2219 H2220	P2904-A P2905-A P2906-A P2907-A				
C007K(KD) C858K(KD)	W811/CRL	232 240 248 356 364	M5232 M5240 M5248 M5356 M5364	E5232ML E5240ML E5248ML E5356ML E5364ML	D5356H	H5356MA	P2763-A P2764-A P2765-A P2766-A P2767-A	—			
	U811/CRL		P0963-A P0964-A P0965-A P0966-A P0967-A								

SIRUBA MODEL COMPARE LIST		Series				Remark			Page	Date
		C007K / C858K C007KD / C858KD				W812 /W813 : 4rof teeth W812A/W813A : 5rof teeth			4 / 7	2015/11/26
										
MODEL		SUB-CLASS	NEEDLE CLAMP	NEEDLE PLATE	MAIN FEED DOG	DIFF. FEED DOG	PRESSER FOOT	SPREADER	LOOPER	NEEDLE
機 型		規 格	針 座	針 板	主送具	差送具	押 具	上 叉	勾 針	針 號
C007K(KD) C858K(KD)	W811A/CRL	232 240 248 356 364	M5232 M5240 M5248 M5356 M5364	E5232NL E5240NL E5248NL E5356NL E5364NL	D5356H	H5356NA	P2763-A P2764-A P2765-A P2766-A P2767-A	MH41	MT01	UYX128GAS#10
	U811A/CRL						P0963-A P0964-A P0965-A P0966-A P0967-A	—		
	W812/CRL			P2763-A P2764-A P2765-A P2766-A P2767-A		MH41				
	U812/CRL			P0963-A P0964-A P0965-A P0966-A P0967-A		—				
	W812A/CRL			P2763-A P2764-A P2765-A P2766-A P2767-A		MH41				
	U812A/CRL			P0963-A P0964-A P0965-A P0966-A P0967-A		—				

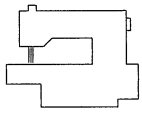
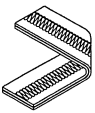
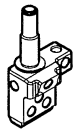
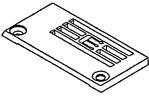
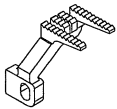
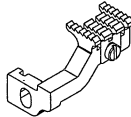
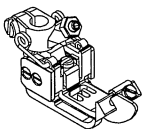
SIRUBA MODEL COMPARE LIST		Series				Remark				Page	Date
		C007K / C858K C007KD / C858KD				W812 /W813 : 4rof teeth W812A/W813A : 5rof teeth				5 / 7	2015/11/26
											
MODEL		SUB-CLASS	NEEDLE CLAMP	NEEDLE PLATE	MAIN FEED DOG	DIFF. FEED DOG	PRESSER FOOT	SPREADER	LOOPER	NEEDLE	
機 型		規 格	針 座	針 板	主 送 具	差 送 具	押 具	上 叉	勾 針	針 號	
C007K(KD) C858K(KD)	W813/CRL	232 240 248 356 364	M5232 M5240 M5248 M5356 M5364	E5232MH E5240MH E5248MH E5356MH E5364MH	D5356H	H5356MA	P2763-A P2764-A P2765-A P2766-A P2767-A	MH41	MT01	UYX128GAS#10	
	U813/CRL						P0963-A P0964-A P0965-A P0966-A P0967-A	—			
	W813A/CRL			P2763-A P2764-A P2765-A P2766-A P2767-A		MH41					
	U813A/CRL			P0963-A P0964-A P0965-A P0966-A P0967-A		—					
	W821/CRL/CHP/UTP/CL/RL			P2763-A P2764-A P2765-A P2766-A P2767-A		MH41					
	U821/CRL/CHP/UTP/CL/RL			P0963-A P0964-A P0965-A P0966-A P0967-A		—					

SIRUBA GAGE PARTS LIST		Series				Remark			Page	Date
		C007K / C858K C007KD / C858KD							6 / 7	2015/11/26
										
MODEL		SUB-CLASS	NEEDLE CLAMP	NEEDLE PLATE	MAIN FEED DOG	DIFF. FEED DOG	PRESSER FOOT	SPREADER	LOOPER	NEEDLE
機 型		規 格	針 座	針 板	主 送 具	差 送 具	押 具	上 叉	勾 針	針 號
C007K(KD) C858K(KD)	W821A/CRL/CHP/UTP/CL/RL	232 240 248 356 364	M5232 M5240 M5248 M5356 M5364	E5232NL E5240NL E5248NL E5356NL E5364NL	D5356H	H5356NA	P2763-A P2764-A P2765-A P2766-A P2767-A	MH41	MT01	UYX128GAS#10
	U821A/CRL/CHP/UTP/CL/RL						P0963-A P0964-A P0965-A P0966-A P0967-A	—		
	W822/CRL/CHP/UTP/CL/RL			E5232MM E5240MM E5248MM E5356MM E5364MM		H5356MA	P2763-A P2764-A P2765-A P2766-A P2767-A	MH41		
	U822/CRL/CHP/UTP/CL/RL						P0963-A P0964-A P0965-A P0966-A P0967-A	—		
	W822A/CRL/CHP/UTP/CL/RL			E5232NM E5240NM E5248NM E5356NM E5364NM		H5356NA	P2763-A P2764-A P2765-A P2766-A P2767-A	MH41		
	U822A/CRL/CHP/UTP/CL/RL						P0963-A P0964-A P0965-A P0966-A P0967-A	—		

SIRUBA GAGE PARTS LIST		Series				Remark				Page	Date
		C007K / C858K C007KD / C858KD								7/7	2015/11/26
											
MODEL		SUB-CLASS	NEEDLE CLAMP	NEEDLE PLATE	MAIN FEED DOG	DIFF. FEED DOG	PRESSER FOOT	SPREADER	LOOPER	NEEDLE	
機 型		規 格	針 座	針 板	主 送 具	差 送 具	押 具	上 叉	勾 針	針 號	
C007K(KD) C858K(KD)	W823/CRL/CHP/UTP/CL/RL			E5232MH E5240MH E5248MH E5356MH E5364MH		H5356MA	P2763-A P2764-A P2765-A P2766-A P2767-A	MH41			
	U823/CRL/CHP/UTP/CL/RL						P0963-A P0964-A P0965-A P0966-A P0967-A	—			
	W823A/CRL/CHP/UTP/CL/RL	232 240 248 356 364	M5232 M5240 M5248 M5356 M5364	E5232NH E5240NH E5248NH E5356NH E5364NH	D5356H	H5356NA	P2763-A P2764-A P2765-A P2766-A P2767-A	MH41	MT01	UYX128GAS#10	
	U823A/CRL/CHP/UTP/CL/RL	P0963-A P0964-A P0965-A P0966-A P0967-A	—								
	W922/CW	456 460 464	M5456K M5460K M5464K	E5456KM E5460KM E5464KM	D5456K	H5456KA-E	P5456K-A P5460K-A P5464K-A	MH41	MT01B	SM1014B#10	











**SIRUBA**

PARTS LIST

Series

C007K/C007KD  
C858K/C858KD

Parts Group

**MF-K**

Subclass / Remark

#: Use for C007KD/C858KD

Page

1/1

Date

2016/01/22

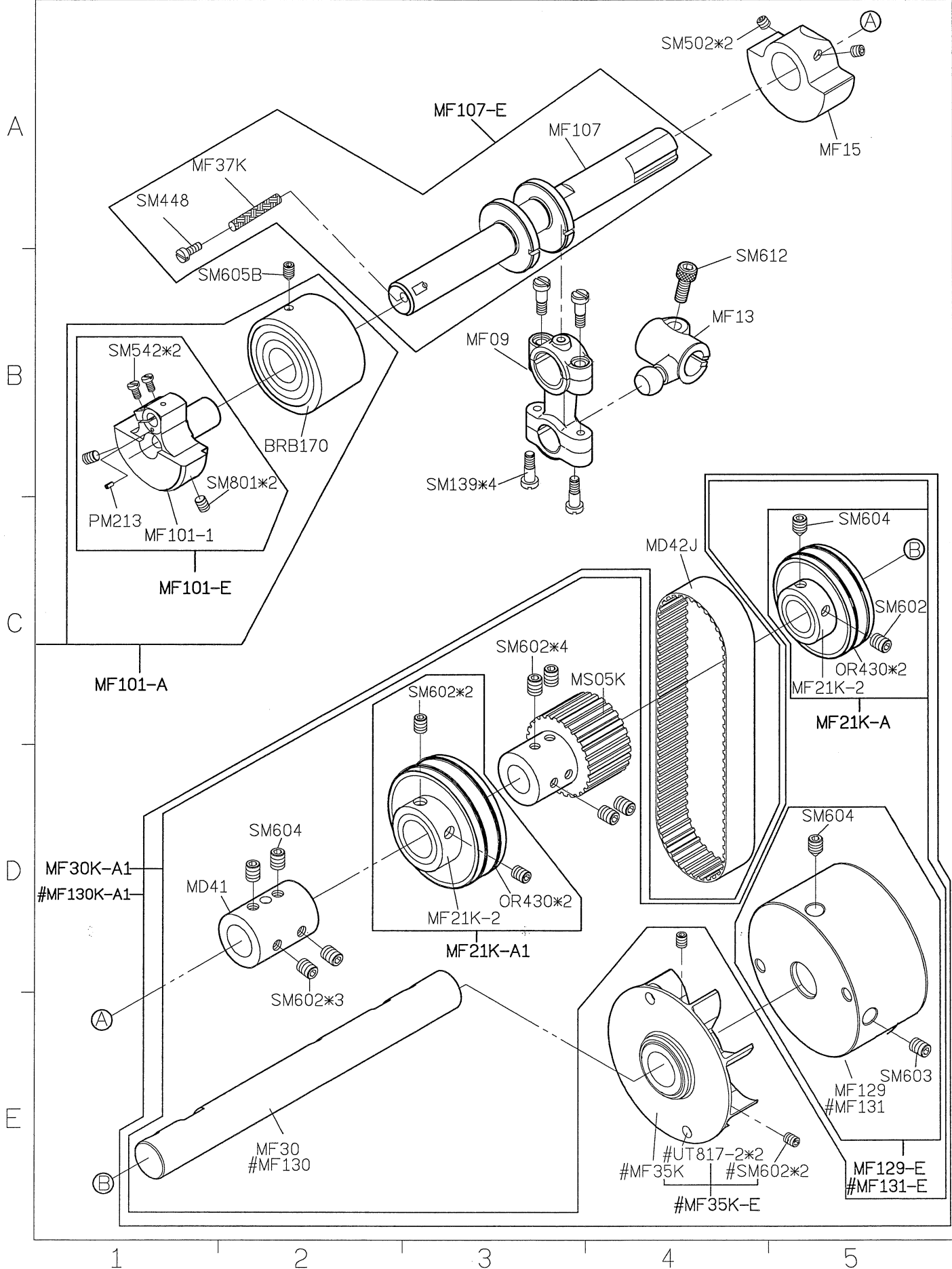

**SIRUBA**

PARTS LIST

Series

C007K/C007KD  
C858K/C858KD

Parts Group

**MG-K**

Subclass / Remark

Page

1/1

Date

2014/12/25

A

B

C

D

E

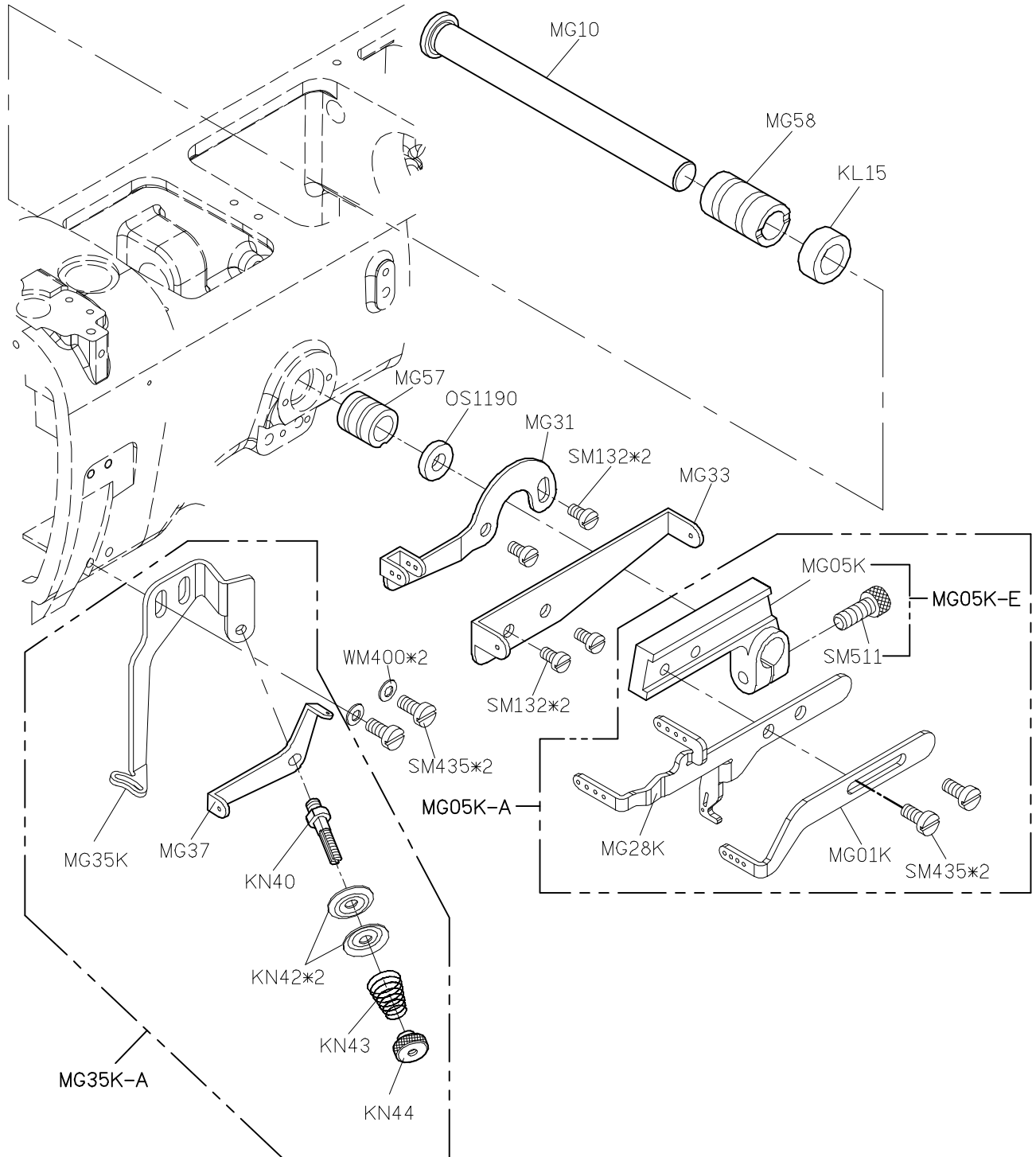

1

2

3

4

5

<b>SIRUBA</b> PARTS LIST	Series	Parts Group	Subclass / Remark	Page
	C007K/C007KD C858K/C858KD	<b>MH-K</b>		1/1
				Date
				2016/01/22

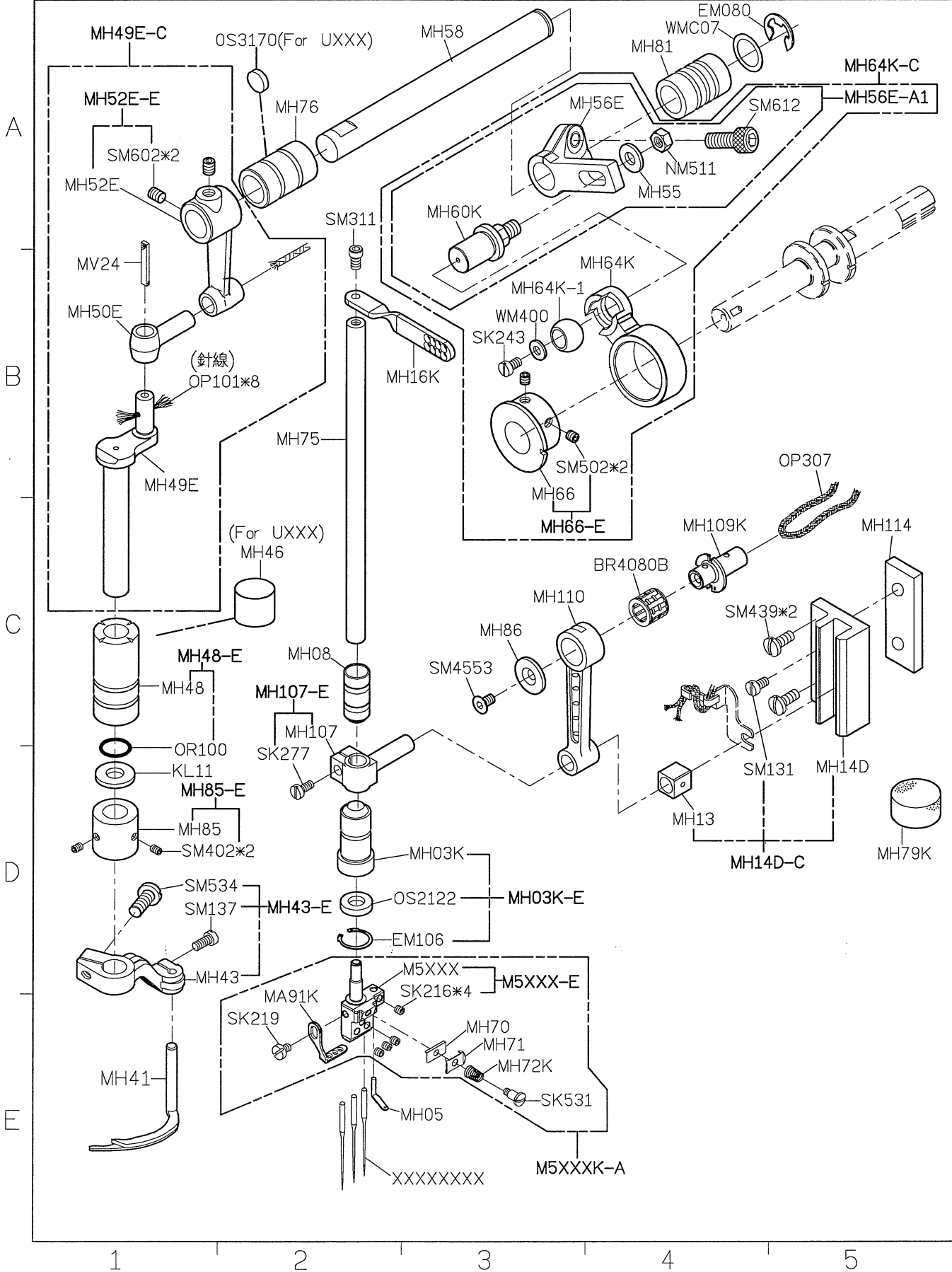

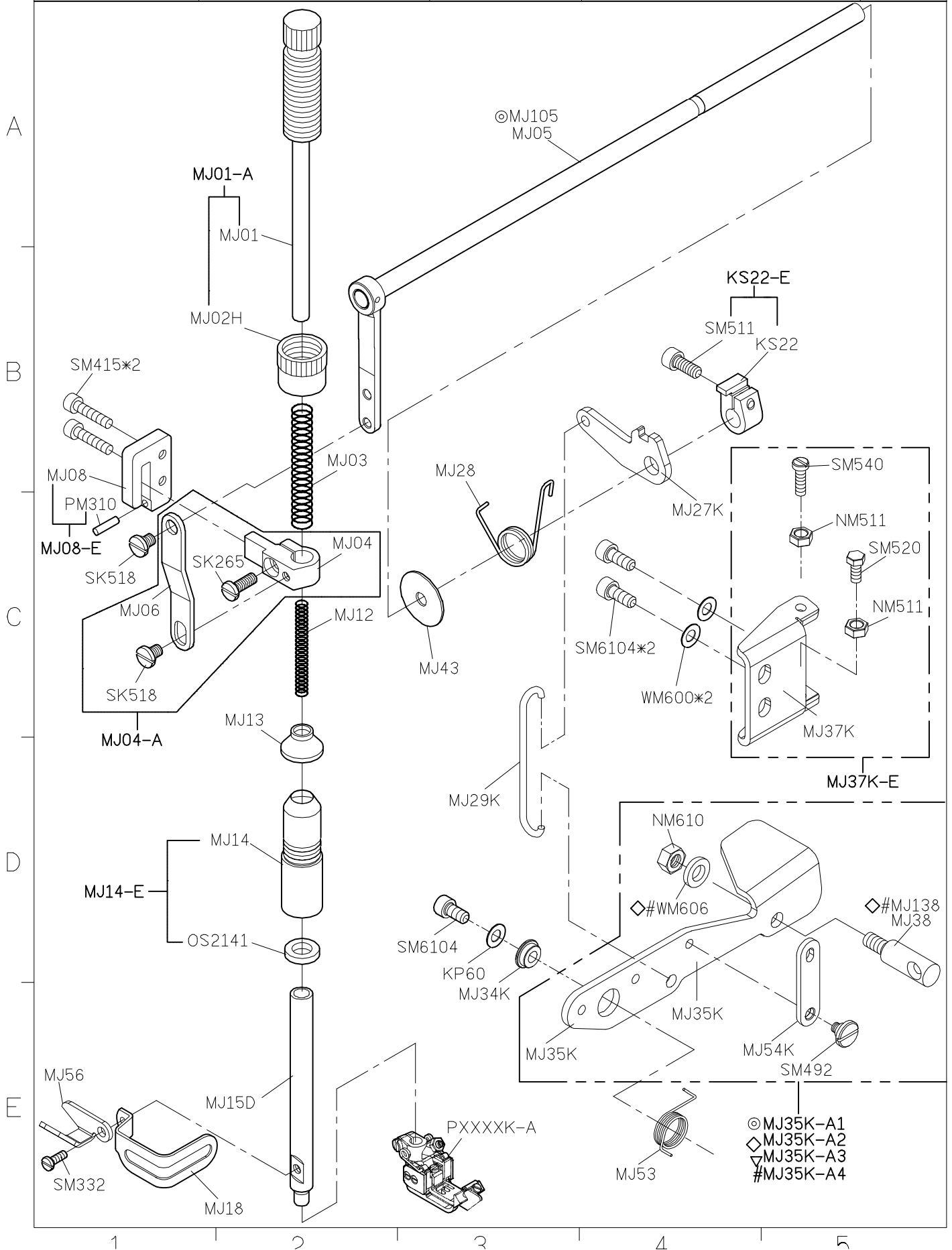

SIRUBA PARTS LIST	Series	Parts Group	Subclass / Remark	Page
	C007K/C007KD	MK-K		1/1
	C858K/C858KD			Date
				2015/12/28

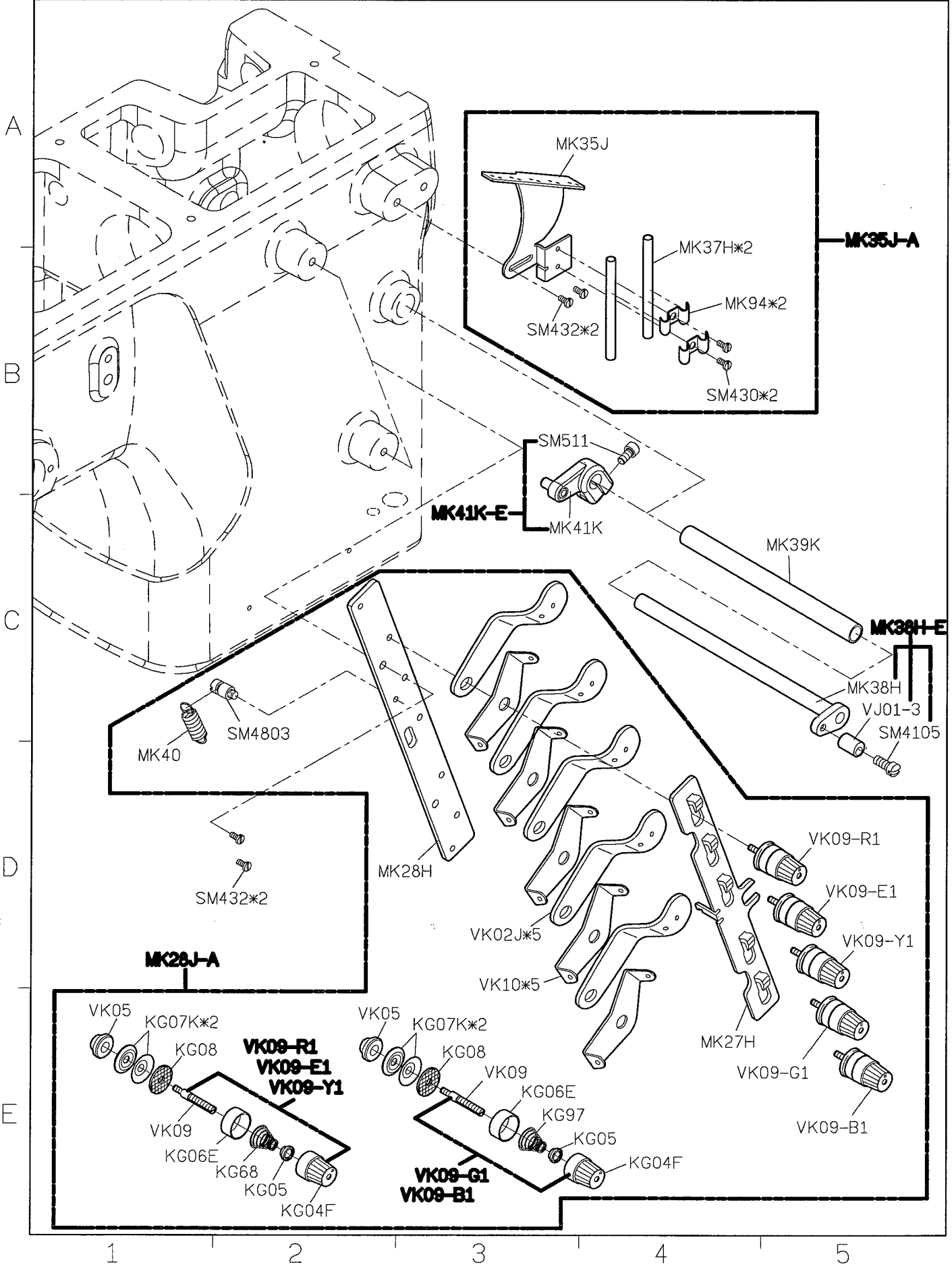



SIRUBA PARTS LIST	Series	Parts Group	Subclass / Remark	Page
	C007K/C007KD	MN-K		1/2
	C858K/C858KD			Date
				2012/11/01

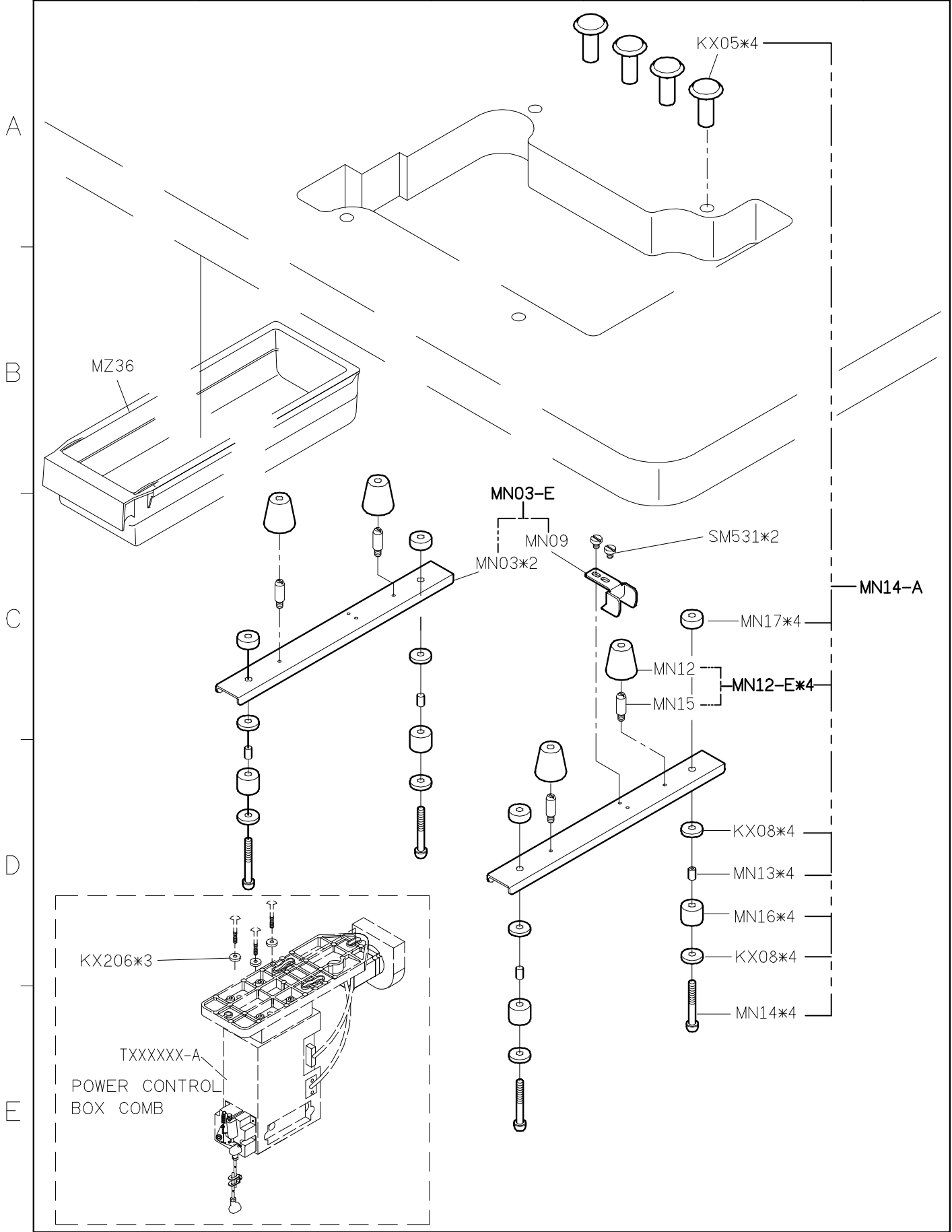

1

2

3

4

5

SIRUBA PARTS LIST	Series	Parts Group	Subclass / Remark	Page
	C007K/C007KD C858K/C858KD	MN-K	#: Use for C007K/C858K	2/2
				Date 2012/11/01

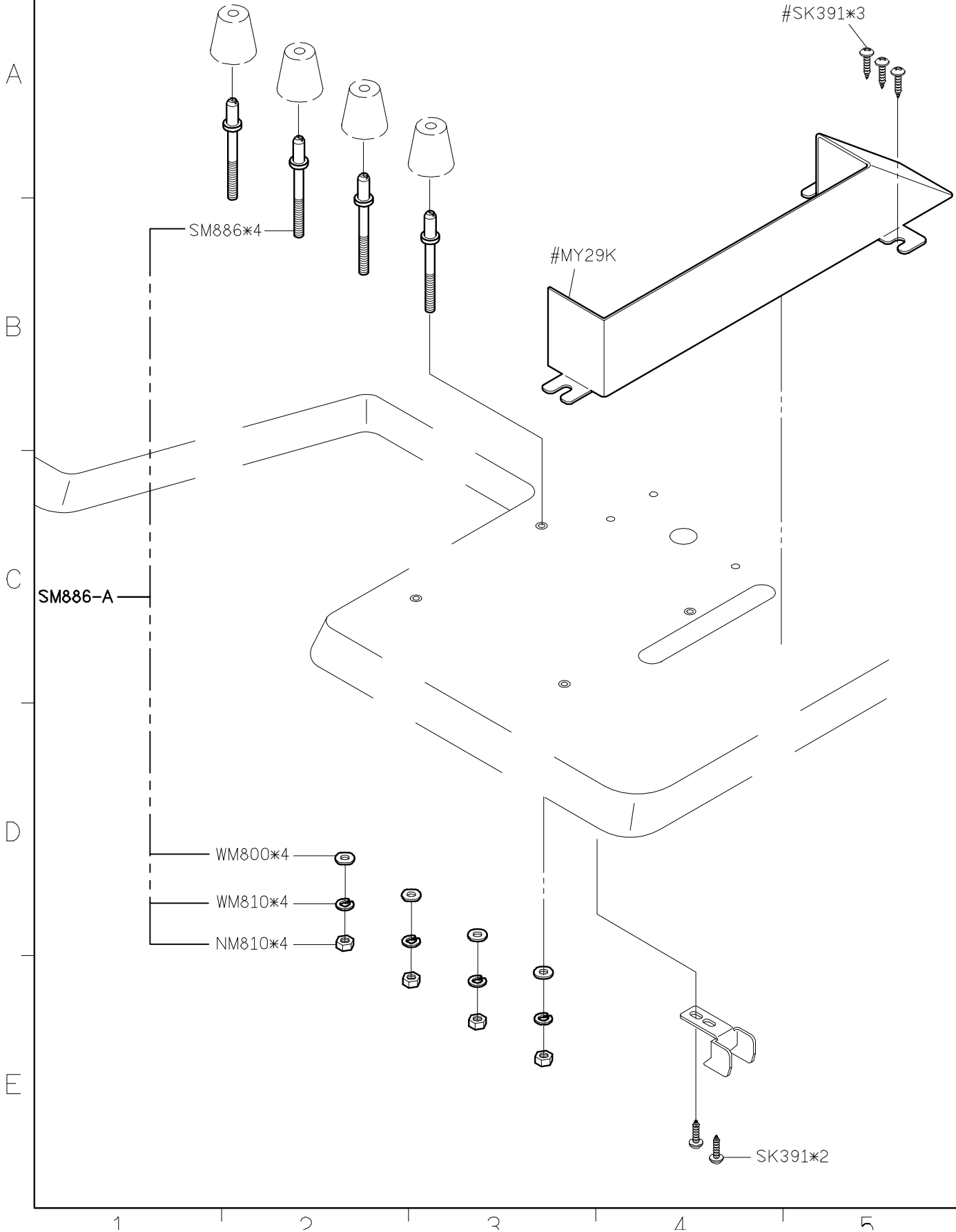







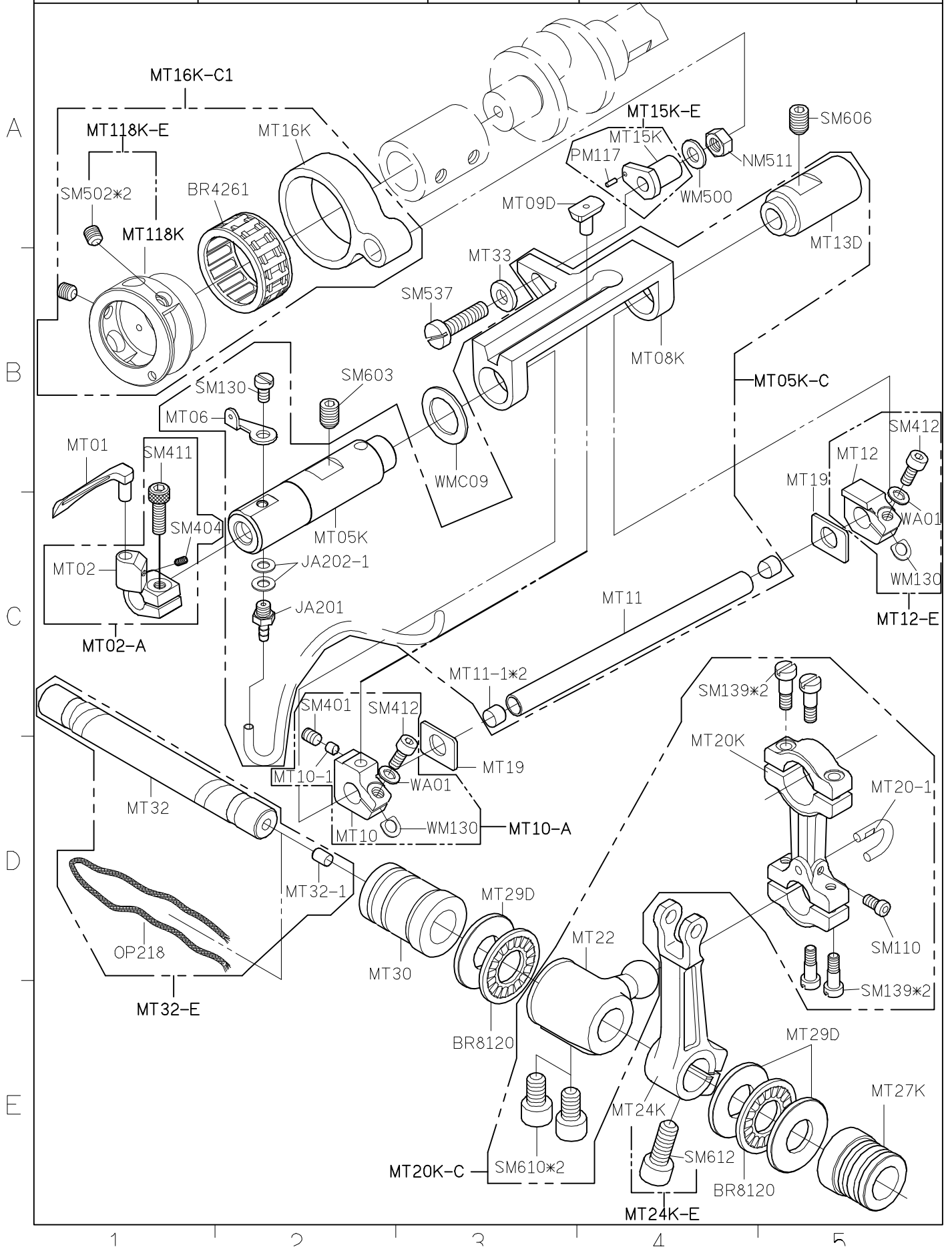

<b>SIRUBA</b> PARTS LIST	Series	Parts Group	Subclass / Remark	Page
	C007K/C007KD C858K/C858KD	<b>MU-K</b>	# : Use for CRL	1/1
				Date
				2015/11/26

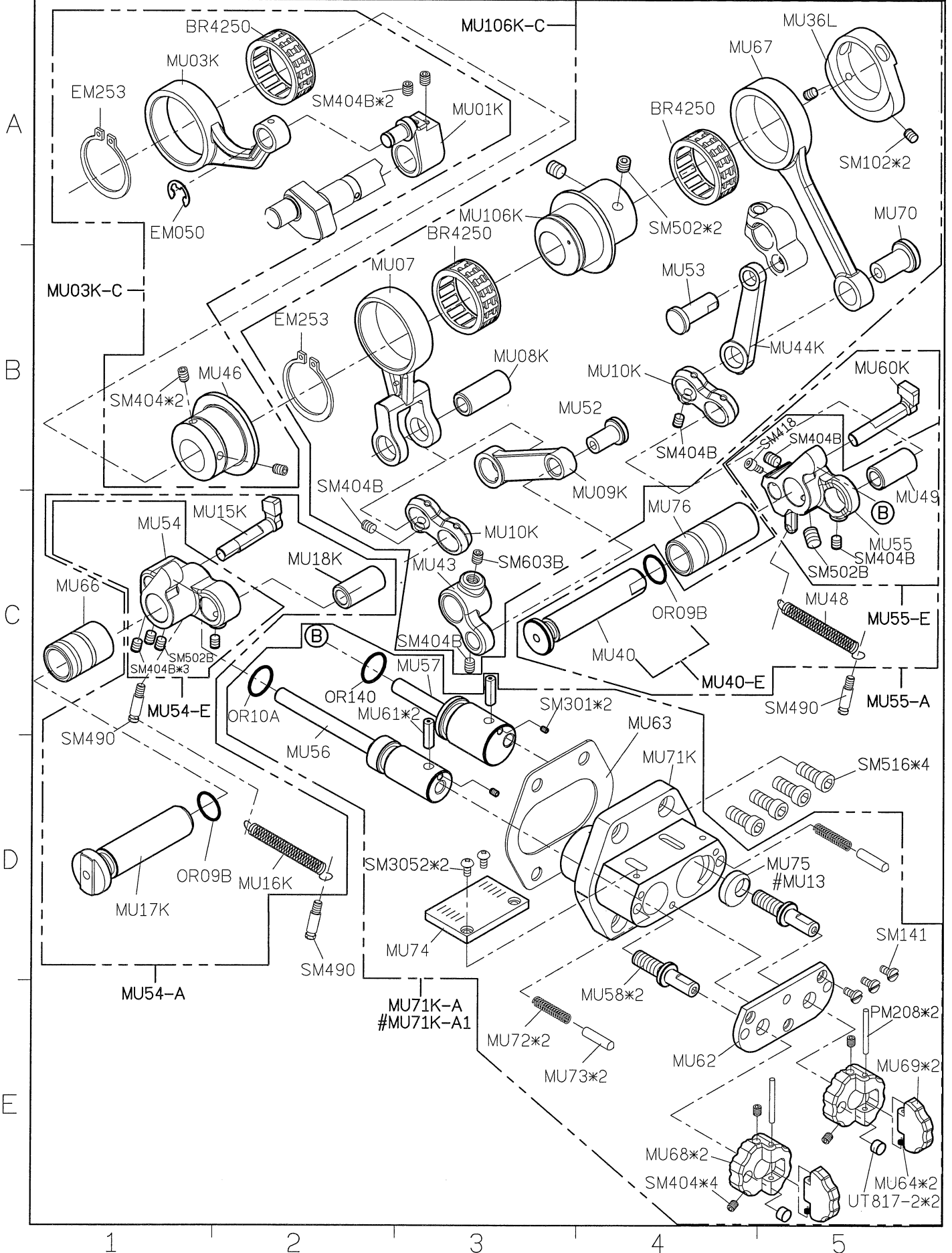

**SIRUBA**

PARTS LIST

Series  
C007K/C007KD  
C858K/C858KD

Parts Group  
**MV-K**

Subclass / Remark

Page

1/1

Date

2015/12/16

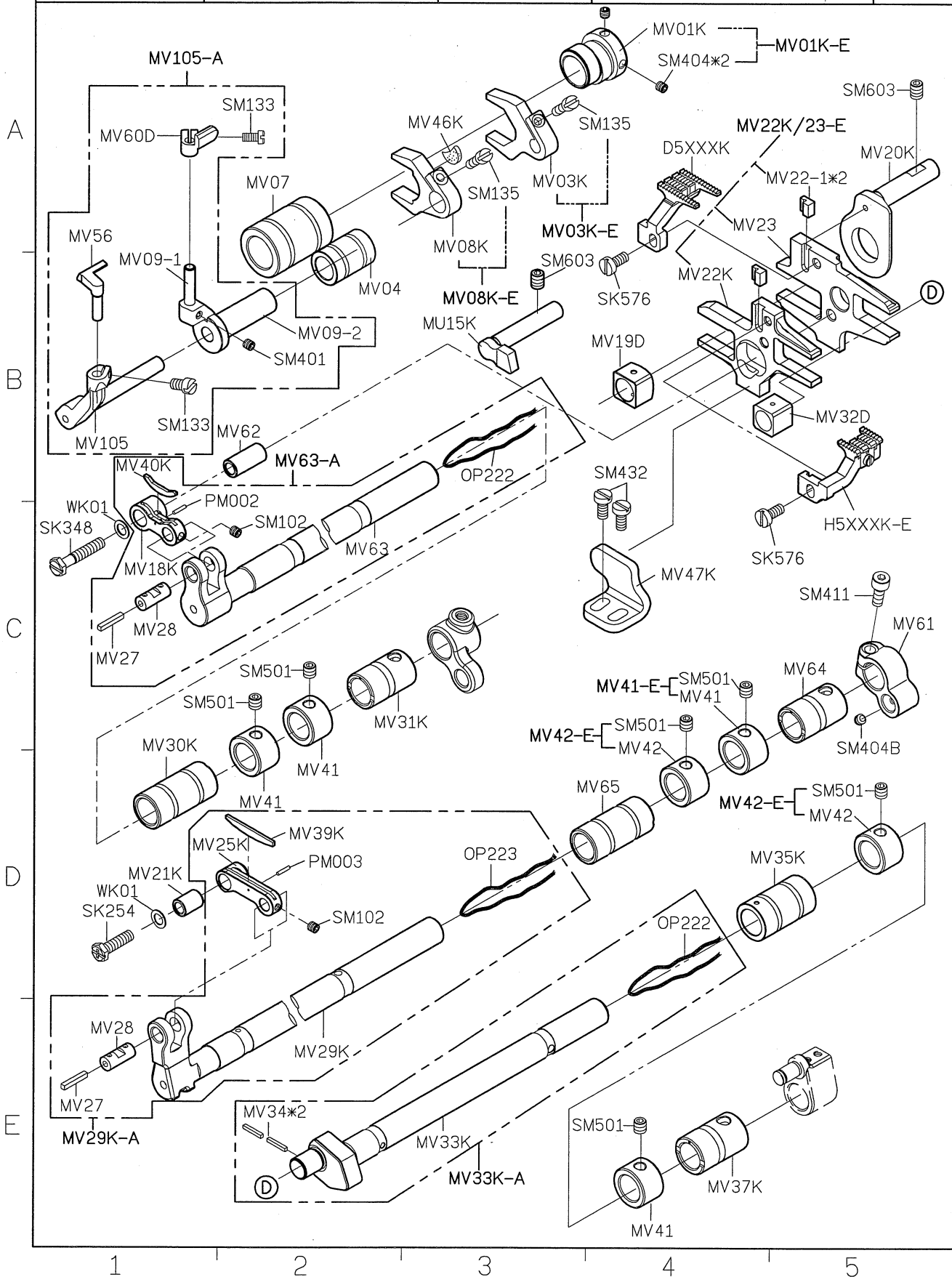





<b>SIRUBA</b> <b>PARTS LIST</b>	<b>Series</b>	<b>Parts Group</b>	<b>Subclass / Remark</b>	<b>Page</b>
	<b>C007K/C007KD</b> <b>C858K/C858KD</b>	<b>MY-K</b>	⊙ : Use for C007K/C858K □ : Use for C007KD/C858KD	1/1
				Date
				2013/10/23

MY01 KY03 KY04 KY05-A KY23-A  
KY23(6/7mm) KY09

MY10-A  
MY09 1.5 2 2.5 3 4 5  
KY10 MY10 MY11 MY12 KY11  
KY14 LY33-A LY33 LY34 KY18

KY20D-A 針\*5 MY21-E KY21-1 MY21 KY201 KZ03

KT14-A ⊙MY29K ⊙SM886-A □SM886-A1  
SM886\*4 WM800\*4 SM886\*4 WM800\*4  
WM810\*4 NM810\*4 WM810\*4 NM810\*4  
SK391\*2 SK392\*3 SK391\*2

MY127K Instruction book (使用説明書)  
MY32K Parts list (零件圖)

Parts list	
Basic mechanism	MY32K
Special mechanism	MY32K
UTP/UTQ	MY32K UT120K
Special machine type + UTP/UTQ	MY32K UT120K
UTR/UTS	MY32K UT240K
Special machine type + UTR/UTS	MY32K UT240K

1 2 3 4 5

SIRUBA PARTS LIST	Series	Parts Group	Subclass / Remark	Page
	C007K/C007KD	MZ-K	#: Use for C007KD/C858KD	1/1
	C858K/C858KD			Date
				2013/03/14

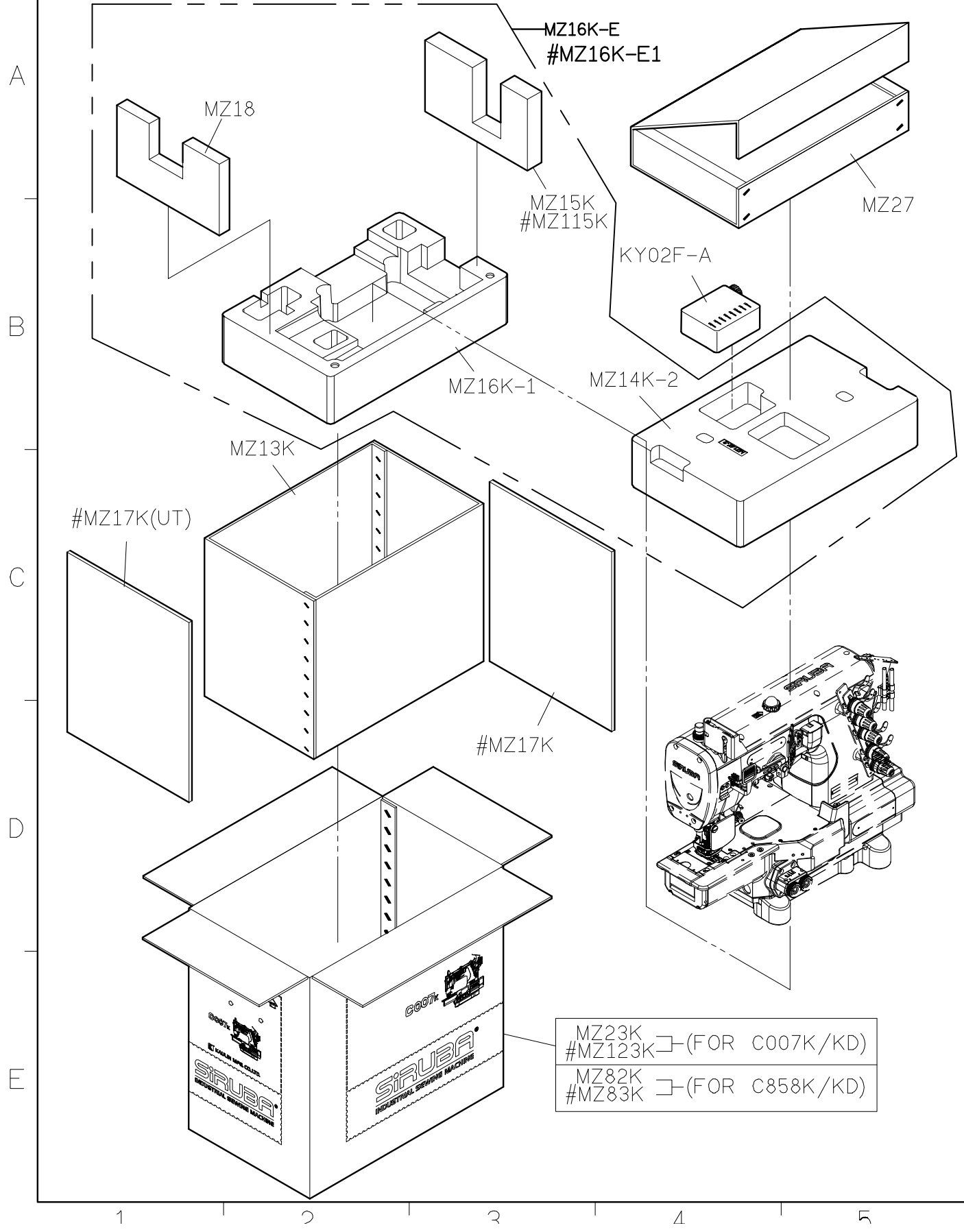

MZ23K	┌ (FOR C007K/KD)
#MZ123K	
MZ82K	┌ (FOR C858K/KD)
#MZ83K	





<b>SIRUBA</b> TABLE CUT - OUT	Series	Item Code	Subclass / Remark	Mounting
	C007K/C858K	C007K-T26	For CFC	Semi-submerged
				Date
				2015/11/27

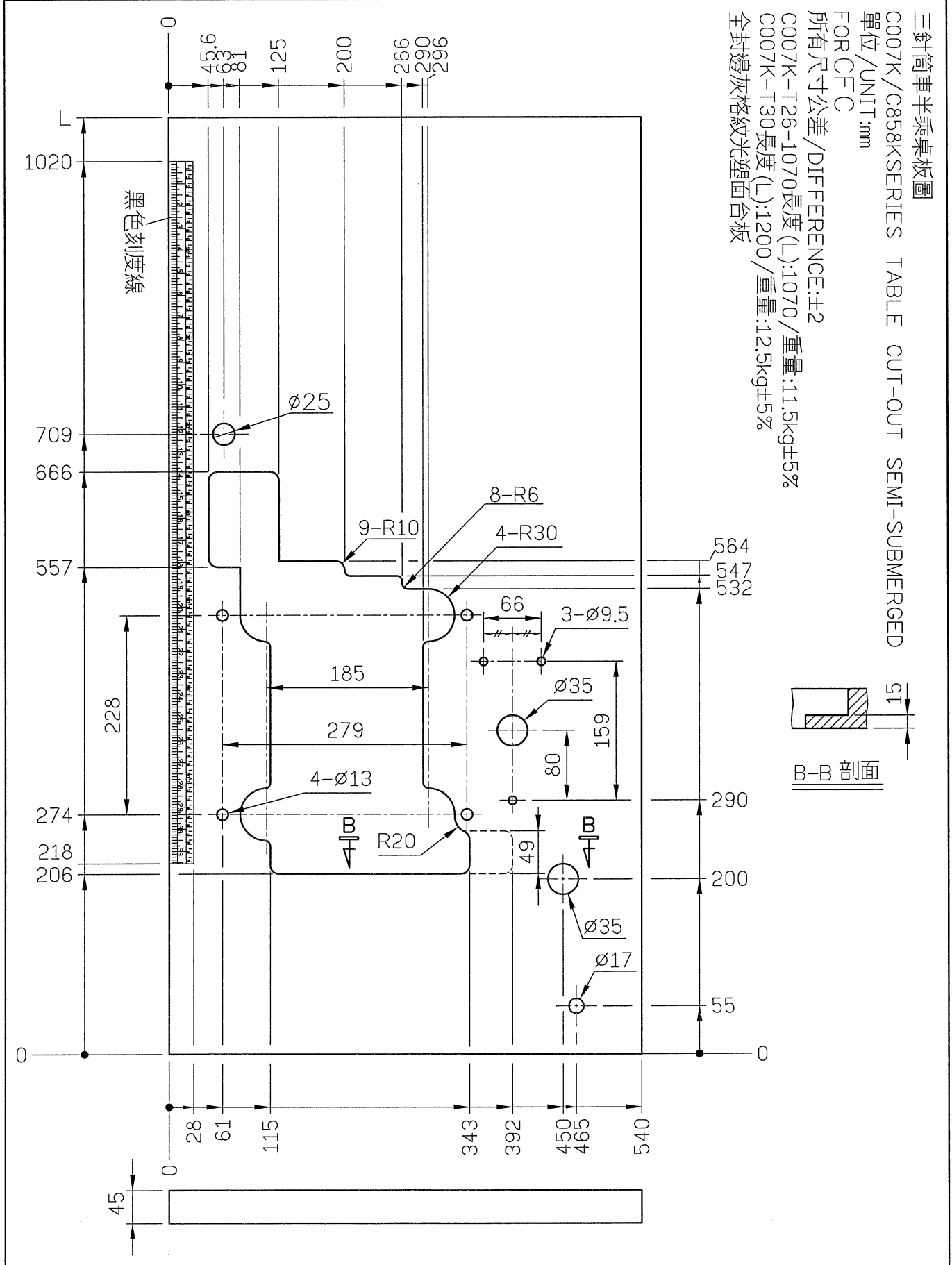

<b>SIRUBA</b> TABLE CUT - OUT	Series	Item Code	Subclass / Remark	Mounting
	C007J/C007K	C007-T30		Non-submerged
				Date
				2015/07/14

三針筒車上乘桌板圖  
 C007J/C007K SERIES TABLE CUT-OUT SEMI-SUBMERGED  
 單位/UNIT:mm  
 FOR 印度客戶使用  
 所有尺寸公差/DIFFERENCE:±2  
 C007-T30-1070長度(L):1070/重量:11.3kg±5%  
 C007-T30長度(L):1200/重量:12.3kg±5%  
 全封邊加格紋光塑面台板

